



FICHE TECHNIQUE
TECHNICAL DATA SHEET
TECHNISCHES DATENBLATT

CS 60023 - 114 a, rue Principale - 67240 GRIES
Tél. 03.88.72.42.41 - Fax. 03.88.72.17.15
E-mail : alsafix@alsafix.com

contact :
technique@alsafix.com

Fiche technique / technical data sheet / technisches datenblatt n°040124

NFA +









100%
NYLON

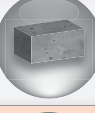
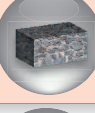

CHEVILLE NYLON A VISSER NFA+
NFA+ SCREW NYLON PLUG
Schraube ANKER Nylon NFA +



Caractéristiques/Specifications/ Spezifikationen

SUPPORT BASE MATERIAL GRUNDSTOFFE		
		N_{rec} (kN)
	BETON CONCRETE BETON	4,0
	STONE PIERRE STEIN	4,0
	SOLID BRICK BRIQUE PLEINE VOLLMAUERWERK	3,5
	NOT SOLID BRICK BRIQUE DEMI-PLEINE SEMIVOLLMAUERWERK	1,2
	HOLLOW BRICK BRIQUE CREUX LOCHZIEGELN	2,0
	HOLLOW CORE HOURDIS HOLZ KAMMER BETON	2,0
	SAND LIME STONE SILICO CALCAIRE KALK SANDSTEIN	1,5

CE Declaration de performance
DoP Declarations of Performance on
www.alsafix.com



R90 F 0,8 kN

100% NYLON

ZINC PLATED 5 µm
ZINGUE 5 µm
VERZINKED 5 µm



INSTALLATION

h_{min} (mm)	c_e (mm)	c_{min} (mm)	s_{min} (mm)
100	100	60	100

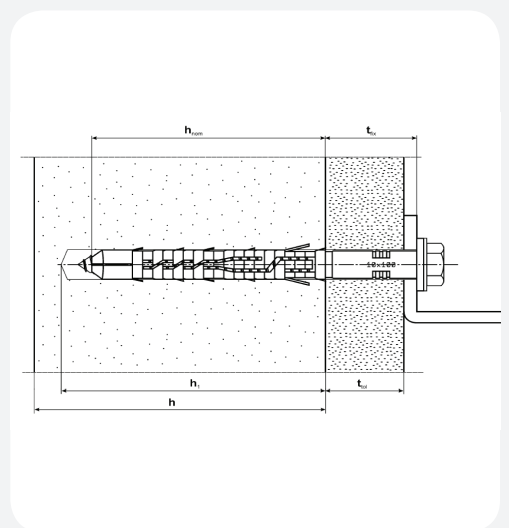
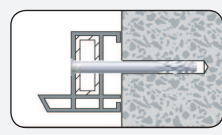
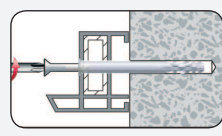
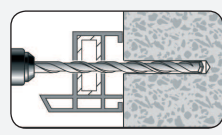

Concrete
Beton

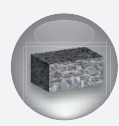

Stone
Pierre



Solid Brick
Brique pleine
Vollmauerwerk



Not Solid Brick
Brique demi-pleine
Semivollmauerwerk



Hollow Brick
Brique creux
Lochziegeln



Hollow core
Hourdis
holz kammer beton



sand lime stone
silico calcaire
kalk sandstein



NFA +

Caractéristiques/Specifications/ Spezifikationen

CODE ARTICLE ARTICULAR NUMBER	NOM NAME													
		$d_0 \times L_0$ (mm)				t_{tx} (mm)	d_{nom} (mm)	h_{vt} (mm)	W_g (mm)	d_0 (mm)	d_1 (mm)	d_2 (mm)	T_{nom} (kN)*	
CM10080TX	NFA+ 10-80 TF	10 x 80 mm	50	600	15	10 mm	10	70	TX40	7	14	10-10,5	15	
CM10100TX	NFA+ 10-100 TF	10 x 100 mm	50	300	10	30 mm	10	70	TX40	7	14	10-10,5	15	
CM10120TX	NFA+ 10-120 TF	10 x 120 mm	50	300	12	50 mm	10	70	TX40	7	14	10-10,5	15	
CM10140TX	NFA+ 10-140 TF	10 x 140 mm	50	300	13	70 mm	10	70	TX40	7	14	10-10,5	15	
CM10160TX	NFA+ 10-160 TF	10 x 160 mm	50	300	16	90 mm	10	70	TX40	7	14	10-10,5	15	
CM10180TX	NFA+ 10-180 TF	10 x 180 mm	50	300	18	110 mm	10	70	TX40	7	14	10-10,5	15	
CM10200TX	NFA+ 10-200 TF	10 x 200 mm	25	125	9	130 mm	10	70	TX40	7	14	10-10,5	15	
CM10230TX	NFA+ 10-230 TF	10 x 230 mm	25	125	10	160 mm	10	70	TX40	7	14	10-10,5	15	
CM10260TX	NFA+ 10-260 TF	10 x 260 mm	25	125	10	190 mm	10	70	TX40	7	14	10-10,5	15	
CM10300TX	NFA+ 10-300 TF	10 x 300 mm	25	125	10	230 mm	10	70	TX40	7	14	10-10,5	15	
CM10080H+	NFA+ 10-80 TH	10 x 80 mm	50	600	15	10 mm	10	70	TX40	13	7	18	10-10,5	15
CM10100H+	NFA+ 10-100 TH	10 x 100 mm	50	300	10	30 mm	10	70	TX40	13	7	18	10-10,5	15
CM10120H+	NFA+ 10-120 TH	10 x 120 mm	50	300	12	50 mm	10	70	TX40	13	7	18	10-10,5	15
CM10140H+	NFA+ 10-140 TH	10 x 140 mm	50	300	13	70 mm	10	70	TX40	13	7	18	10-10,5	15
CM10160H+	NFA+ 10-160 TH	10 x 160 mm	50	300	16	90 mm	10	70	TX40	13	7	18	10-10,5	15
CM10180H+	NFA+ 10-180 TH	10 x 180 mm	50	300	18	115 mm	10	70	TX40	13	7	18	10-10,5	15
CM10200H+	NFA+ 10-200 TH	10 x 200 mm	25	125	9	140 mm	10	70	TX40	13	7	18	10-10,5	15
CM10230H+	NFA+ 10-230 TH	10 x 230 mm	25	125	10	160 mm	10	70	TX40	13	7	18	10-10,5	15
CM10260H+	NFA+ 10-260 TH	10 x 260 mm	25	125	10	190 mm	10	70	TX40	13	7	18	10-10,5	15
CM10300H+	NFA+ 10-300 TH	10 x 300 mm	25	125	10	230 mm	10	70	TX40	13	7	18	10-10,5	15

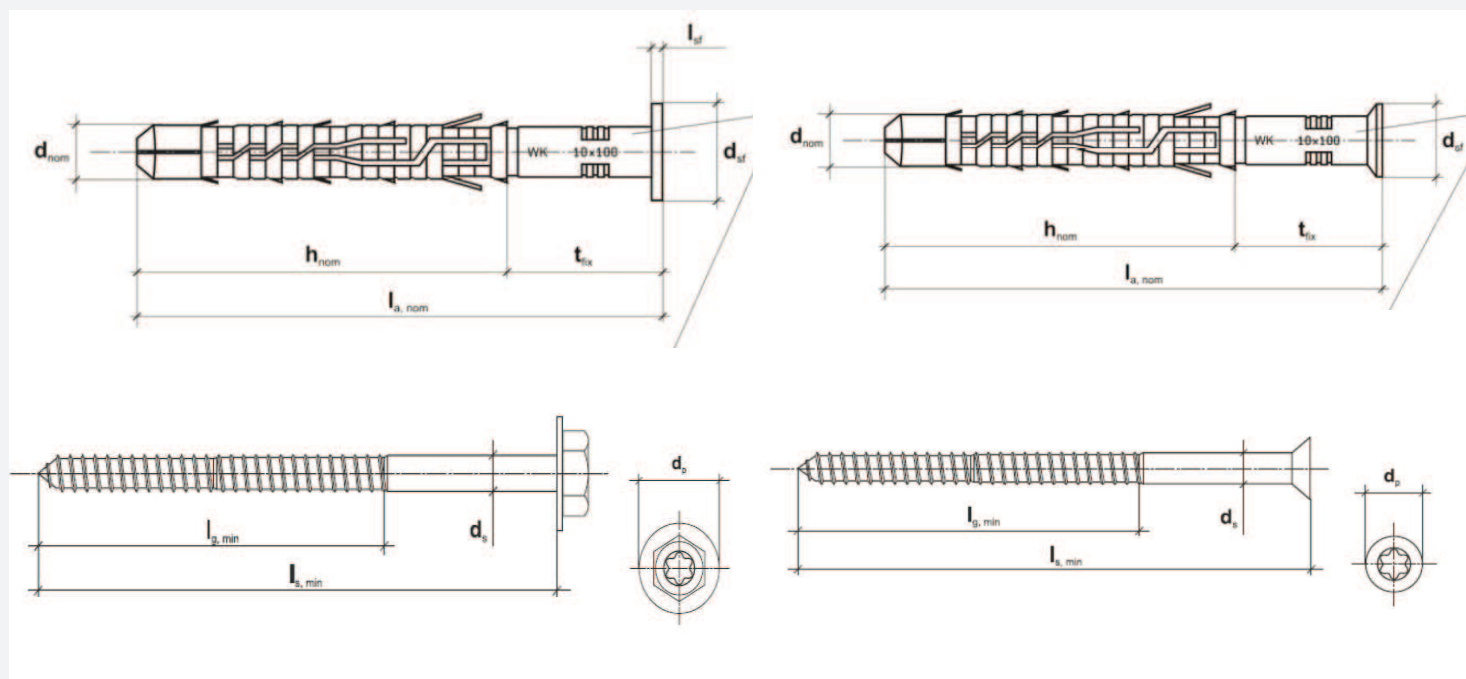

Informations

Produits ALSAFIX associés / ALSAFIX Associated product / ALSAFIX zugehörigen Produkt



EY75A2LS2F



EY7880LZ



EY7441LSF



12IT250



134IK11



134IK24



EY75A2LS2F

Sous réserve de modifications. Informations données à titre indicatif, Alsafix ne serait être tenu responsable en cas de mise en oeuvre sans calcul et essais préalables propres à chaque cas.
this document is Subject of modifications. Informations data indicative ALSAFIX not be held liable for any implementation without prior calculation and testing of each case.
Betreff modifications. Informations Daten, ALSAFIX nicht haftbar gemacht werden für die Umsetzung ohne vorherige Berechnung und Prüfung jedes einzelnen Falles werden.

